

# 2 000 lt Vertical Water Tank

This is a stock item in specific colours

**FRONT VIEW**

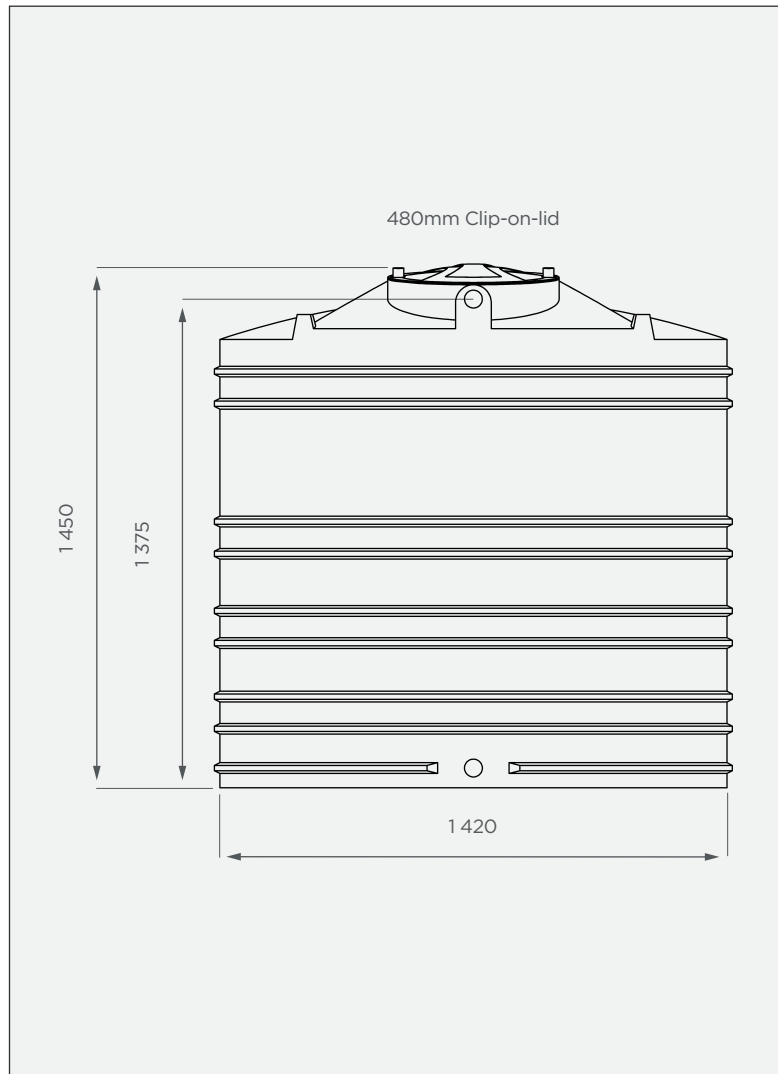

**TOP VIEW**

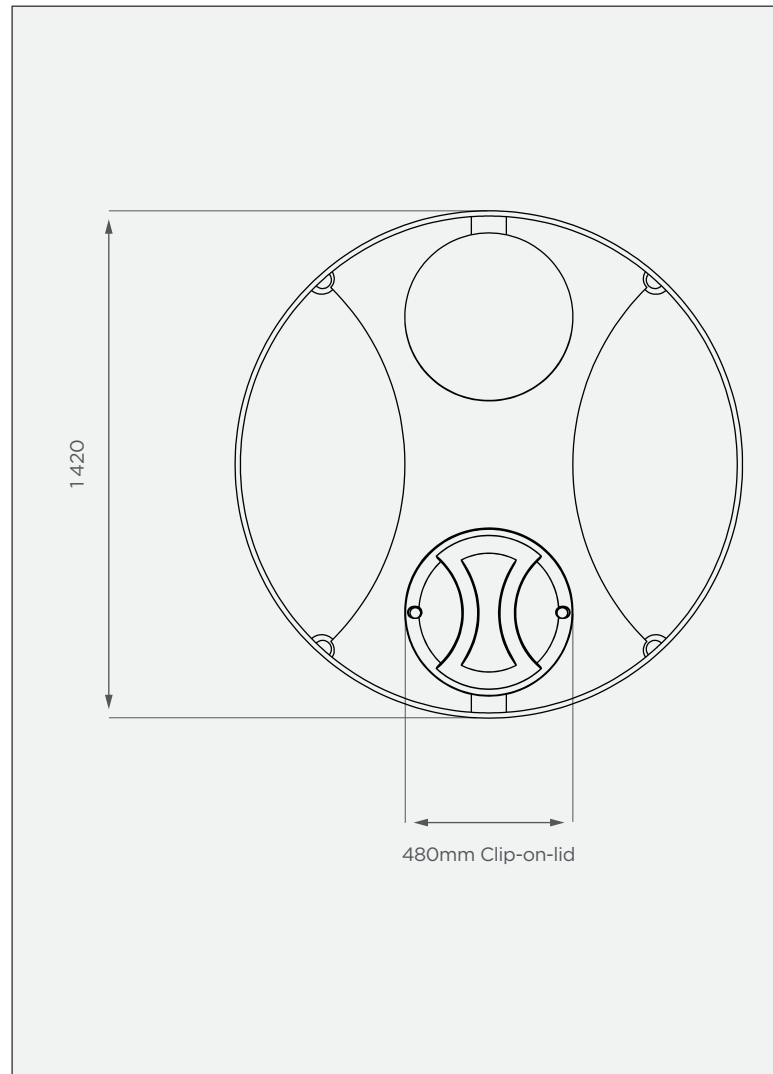

**PRODUCT SPECIFICATIONS**

Water	SG 1
Inlet	40mm female water fitting
Overflow	No Overflow
Outlet	40mm water fitting
Lid	480mm

**Standard Colours**

Stock items are subject to a 7 calendar day lead time.



**Alternative Colours**

These colours are available at a 14 calendar day lead time.



Note: Any colours not mentioned above can be custom manufactured at extended lead times.

**10-year warranty**



- Made with the best quality virgin LLDPE
- UV-stabilised outer layer
- BPA-free, food-grade layer prevents leaching of harmful chemicals
- Black inner layer prevents algae growth

All dimensions are in millimeters and scale is not 100% to scale. This drawing is the property of JoJo.