

Stainless Steel VSD Booster Pump Range

Instructions for use







December 2023

Features & Benefits

- ✓ 1-year Quality Warranty
- ✓ NRCS approved
- ✓ Low noise level
- ✓ Energy-efficient
- ✓ Easy to operate
- ✓ Restart delay
- ✓ Auto-rotation
- ✓ Constant pressure
- ✓ Ideal for solar systems
- ✓ Automatic start/stop function
- ✓ Pre-wired with a 3-point plug
- ✓ Dry run protection
- ✓ Over-current protection
- ✓ Overload and abnormal pressure protection

APPLICATIONS



		 or  or 				
Pump	Bathrooms	Misting	Pop up	Impact	Dishwasher	Washing Machine
0.75kW	3	30	6	3	Yes	Yes
1.5kW	4	35	8	4	Yes	Yes

⊕ Get the most out of your purchase!

- Add a JoJo Pump Cover to protect your pump from the elements and prolong its lifespan.

1-year Quality Warranty

JoJo pumps purchased from an approved JoJo retail outlet and/or distributor carry a 1-year warranty from the date of purchase. In order to maintain your warranty, always ensure you install, operate and maintain the pump as per the instructions provided in this manual.

Detailed T's and C's, as well as return policies and procedures are in the back of this manual.

1
YEAR
WARRANTY

Performance table

Pump specifications	0.75kW	1.5kW
Pump model	HMS750	HMS1500
Motor power	0.75kW	1.5kW
Max. flow	75 lt/min	150 lt/min
Max. pressure	5.3 bar	5.6 bar
Max. fluid temperature	80 °C	80 °C
Max. ambient temperature	40 °C	40 °C
Max. suction lift	7m	7m
Protection	IP 44	IP 44
Suction size	25 mm/1"	32 mm/1 ¼"
Discharge size	25 mm/1"	25 mm/1"



Best efficiency range

Flow range	0.75kW	1.5kW
Lt/min	28 to 56 lt	51 to 120 lt

Pressure range	0.75kW	1.5kW
Bar	2 to 4 bar	2 to 4.5 bar

Performance Curves

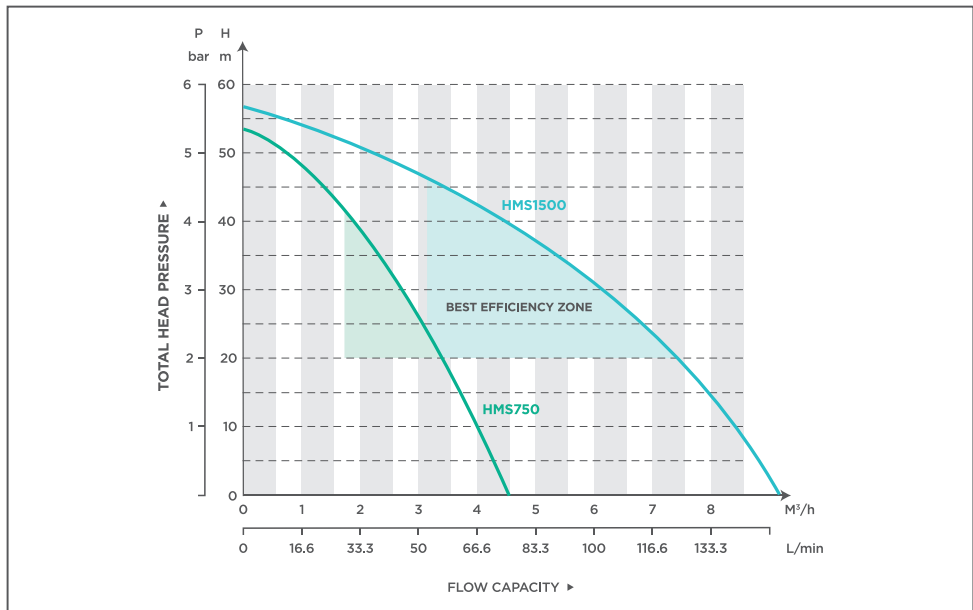

i Important Information

- The pump must be earthed with no strain placed on the electrical cable.
- All maintenance should be carried out with the power supply disconnected.
- The pump is designed for clean water use only, i.e. water containing no solid particles. Pumping muddy water or water containing suspended solids will severely reduce the lifespan of the unit and falls outside of the factory warranty.
- Carefully read the instructions before adjusting any settings. Please contact JoJo should you need assistance.
- Extending the cable will affect your factory warranty. Always make use of an approved extending plug adapter.
- The pump should be installed in a ventilated, undercover area to protect the unit against direct sunlight, rain and spray from any irrigation system. A JoJo pump cover is recommended for best protection.
- The booster pump is equipped with a draining screw at the bottom of the suction/discharge casing. It is advised to drain the unit when temperatures fall below 0°C.

	Recommended suction pipes:	Recommended discharge pipe:
0.75kW	<ul style="list-style-type: none"> • HDPE (minimum 1" or 25mm) • Helical coil reinforced flexible hose 1" or 25mm 	HDPE (minimum 1" or 25mm class 6)
1.5kW	<ul style="list-style-type: none"> • HDPE (minimum 1^{1/4}" or 32mm class 6) • Helical coil reinforced flexible hose 1^{1/2}" or 40mm 	HDPE (minimum 1" or 25mm class 6)

INSTALLATION

Foundation

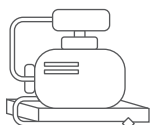

The foundation should be solid enough to support the pump. It is recommended to secure the unit by bolting it to a concrete or paved surface.

Before building the foundation, take the following into consideration:

- The placement of the pump incl. the direction of inlet/outlet.
- The height: ensure that the water level in the tank is higher than the suction side of the pump.

Mounting

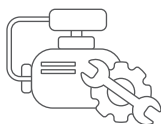

- A level base is essential to ensure the pump shaft is aligned horizontally.
- The pump suction line and fittings must all be on a horizontal plane to ensure there are no high points in the pipeline where air can get trapped.
- The discharge line and fittings must be on a vertical plane.

Piping

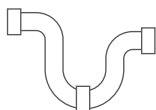

- The suction and discharge pipes should be supported independently by utilising pipe hangers and support blocks - this will prevent strain on the pump joints and casing.
- Before making a connection, check the pipe alignment to ensure it is correct.
- The inlet and discharge pipe should align with the pump to ensure there are no bends or kinks that might affect the flow.
- The inlet and discharge pipe/connections must correspond with the design specifications of the pump as it may directly affect the efficiency and power consumption of the pump.
- The diameter of the suction and discharge pipe must be equal or greater than that of the ports of the pump.
- When used as an alternative water supply for a home, install non-return valves to ensure no back pressure to the municipal supply or the pump.

PRIMING INSTRUCTIONS

IMPORTANT: always prime the pump before use to ensure proper functionality and to prevent possible damage to any of the components.

01. Remove the priming screw located on top of the pump.
02. Fill the pump volute manually with water until it overflows. *Note: this unit is equipped with a spring-loaded non-return valve and will not prime automatically (even if connected to a tank).*
03. Put the priming screw back in place and then tighten, (do not over tighten). Ensure that there are no leaks.

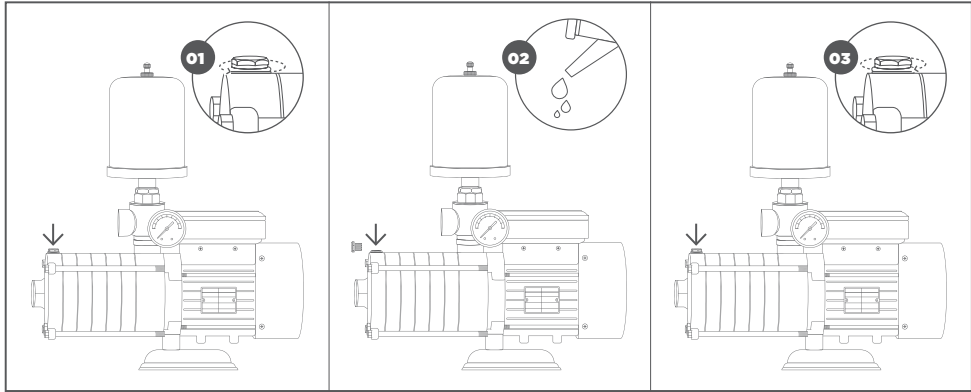

OPERATING INSTRUCTIONS

01. Ensure that the power supply cable is plugged in properly.
02. The booster pump is designed to operate with a 230V single-phase power supply. Voltage variance is maximum 10% up or down. Further variance will damage the electrical motor and/or result in errors.
03. The suction and discharge piping should be of rigid characteristics, be able to withstand pressure of up to 6 bar, be air tight on the suction side, and water tight on the discharge side.

SETTINGS

IMPORTANT: changing the default settings is not recommended, as it enables the unit to respond optimally to potentially harmful system conditions.

This booster pump may operate safely for 3 minutes after dry run conditions have been logged. Please follow the steps on the following pages to set up your pump.

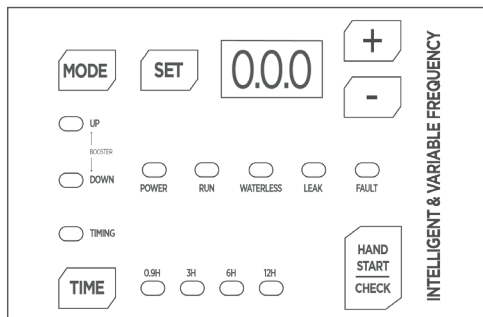

01. Press **"MODE"** until reaching the desired category.
- 01.1 Mode **"UP"** must always be selected for installations where the pump is installed on ground level and supplies pressure parallel to, or vertically up into a system.
- The screen will display the working pressure (bar).
 - Press **"+"** to increase the set pressure.
 - Press **"-"** to reduce the set pressure.
 - The new set point will flash five (5) times before saving the value.
 - The recommended operating range is between 2 bar and 4.5 bar.
- Important: Do not exceed 4 bar for residential use.**

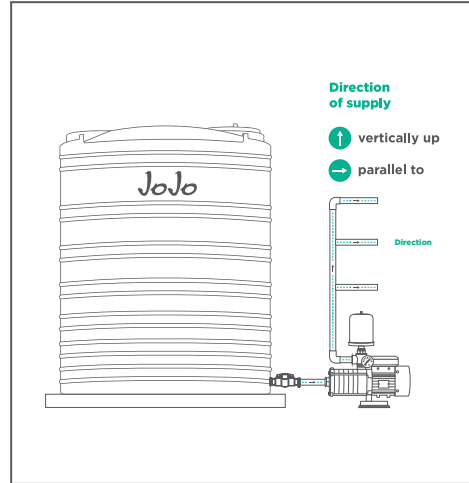

02. Press **"SET"** to enter the settings menu (once entered B01 is displayed). Use **"+"** or **"-"** to cycle between functions, and press **"SET"** again to access the desired function.

B01 to B07.

02.1 B01: START-UP PRESSURE

- When **B01** is displayed and **"SET"** is pressed, the start-up pressure can be adjusted as a percentage of the working pressure. The default ratio is set at 70%. Use commands **"+"** or **"-"** to increase or decrease this ratio. Press **"SET"** to save the new value.
- For example, working pressure set at 3.0 bar and ratio set at 70%:
 $3.0 \text{ bar} \times 0.7 = 2.1 \text{ bar}$
- Once water usage has stopped, the pump will allow system pressure to drop to 2.1 bar before starting up.

02.2 B02: DIRECTION OF ROTATION

- Must **ALWAYS** be set to **"OO"** to ensure the correct direction of rotation.

02.3 B03: DRY RUN PROTECTION

- When **B03** is displayed and **"SET"** is pressed, the screen will display a value between **0** and **1.5** bar. The default is set at 0.5 bar and is the pressure at which the pump will switch off when it runs dry or against low back pressure, for example, as caused by a burst discharge pipe. Using **"+"** or **"-"** will increase or decrease this value. Press **"SET"** to save the new value. **Note: it is not recommended to change this default setting as it enables the unit to operate in its highest efficiency zone and most accurately mimics municipal pressure supply conditions.**

02.4 B04:

- **180 Seconds** at dry run condition before automatically stopped
 - **DO NOT CHANGE THIS SETTING.**

02.5 B05: NOT IN USE

02.6 B06: PRESSURE AND FREQUENCY

- When **B06** is displayed and **"SET"** is pressed, the screen will display a value of **00**. This is the default setting which shows the pressure in the system. Should you want to adjust this to view the frequency of the AC power supplied to the motor, you can do so by pressing **"+"** to change it to **01** and pressing **"SET"** to save the new setting. After a few seconds the VSD will return to the home screen and show the updated frequency value.

02.7 B07: SHUT-OFF STABILITY

- The default is 30. **Note: it is not recommended to change this default setting as it is equal to the sensitivity of the shut-off pressure fluctuations. Reducing this value will cause the unit to be less sensitive to pressure and result in a quick response to stop the pump once it has reached the desired pressure.**

03. Indicator lights and fault codes:

03.1 Mode **"UP"**:

- The **"POWER"** light will be illuminated.
- The **"RUN"** light will illuminate when the pump is operating.
- The **"RUN"** light will flash when the pump is operating but is unable to reach the set pressure. This is not unusual, as the application for household supply and irrigation supply vary vastly in flow demand.
- The **"LEAK"** light will illuminate in the event of a pressure leak in the discharge line.
- If an error code appears on the screen, please refer to the troubleshoot guide on page 7.
- Press the **"HAND START/CHECK"** button to reset all fault codes. Press again to resume automatic operation.
- Operating under the **"UP"** or **"DOWN"** mode will disable the **"TIMING"** light and function.

03.2 Mode **"TIME"**:

- **"TIME"** retains all settings of **"UP"** mode, but allows for the selection of a restart time. For example, **"3H"** will start the pump every 3 hours without the system demanding an automatic start. This function is important for applications where the unit may not be required to operate for extended periods of time e.g. a holiday home, weekend retreat, etc.
- Daily starts keep the rotating equipment in good condition and prevents damage to bearings.

03.3 Mode **"DOWN"**:

- Must **ONLY** be selected for installations where the pump is installed on the upper level and supplying pressure vertically down into a system. Selecting this option will reduce the overall pressure delivered by the pump to protect against over pressurizing lower lying systems.

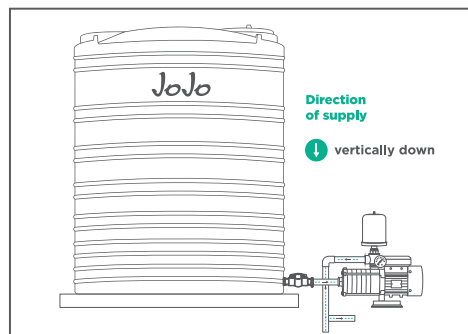

TROUBLESHOOTING GUIDE

If an error code appears on the screen, please refer to the below guide for more information.

E01	Low voltage supply (below 130V)	The supply voltage is too low. This is generally a fault from the local municipality.	Turn the pump off and disconnect it from the power source. Proceed to contact a registered electrician to inspect your power supply.
E02	High voltage from supply (above 280V)	The supply voltage is too high. This is generally a fault from the local municipality and can damage your pump.	Turn the pump off and disconnect it from the power source. Proceed to contact a registered electrician to inspect your power supply.
E03	Pressure transducer disconnected/faulty	Caused by a loose cable or damaged pressure transducer.	<ul style="list-style-type: none"> • Check the transducer cable to see if it is damaged or unplugged. • If within the 12 month warranty period and the cable is intact, return the unit to the supplier you purchased it from, otherwise contact JoJo for further assistance.
E04	Motor temperatures exceeding operating limits	The pump is overheating. This is generally due to poor ventilation caused by installing the motor fan end closer than 100mm from the nearest vertical surface e.g. a wall or covering.	<ul style="list-style-type: none"> • Ensure that the motor is installed with sufficient spacing (min. 100mm) between a surface and the motor fan to allow for sufficient cooling. • Ensure the motor has sufficient ventilation.
E08	Locked rotor	Caused by objects such as stones, plant matter, string, sand, or mineral build-up entering the system from the supply side and lodging in the pump casing, thus preventing the impeller from rotating.	<ul style="list-style-type: none"> • Remove the suction and discharge piping and inspect the inlet and outlet for any visible obstruction/s. Remove the obstruction/s if visible. • If within the 12 month warranty period and the error code continues to display, return the unit to the supplier you purchased it from, otherwise contact JoJo for further assistance.
E09	Variable speed drive PC board fault condition	Caused by power spikes, and under voltage or over voltage that damage the PC board. Continued faults of this nature indicate power grid instability and can lead to permanent damage of the electronic circuitry.	<ul style="list-style-type: none"> • IMPORTANT: this is not covered by the warranty. • Please contact JoJo for further assistance. Even though this is not covered by the warranty, we will assess the pump to determine the extent of the damage and advise whether a repair is possible.
E05, E06, E07, E010 & E011 - Not in use			

JOJO PUMP WARRANTY

Please read this warranty in conjunction with the South African Consumer Protection Act 68 of 2008.

- 01.** JoJo warrants its pumps to the original end user/purchaser to be free of defective materials and workmanship under normal use for a period of 12-months from the date of purchase from authorised retailers and distributors. To be eligible for warranty repair or replacement, the pump must be returned to the point of purchase during and up to the expiry date of the warranty period. Proof of date of purchase is required.
- 02.** Liability in terms of this warranty shall be limited to repair or replacement of the pump. Liability for all and any other losses and/or subsequent damages suffered are expressly excluded.
- 03.** This warranty does not obligate JoJo to bear any cost of removal, installation, transportation, or other charges which may arise in connection with a warranty claim.

- 04.** The warranty shall not apply to repairs or service necessitated by normal wear and tear or for lack of reasonable and proper maintenance.

This warranty does not apply if in the sole judgement of JoJo the product or any of the components have been;

- (a) Tampered with, disassembled (unless as per JoJo's specific instructions relevant to peripheral pumps and clearly displayed on fan cover), repaired or altered (except as may be pre-authorized by JoJo in writing);
- (b) Subjected to misapplication, misuse, neglect or accident; or
- (c) Used to pump anything for which the pump was not designed. Such use may compromise or harm the pump and/or any of its components.

IMPORTANT: this is the exclusive warranty given by us and no other warranty or guarantees, expressed or implied shall be of any force or effect. No distributor or other person is authorised to assume any liability or obligated for JoJo other than expressly provided herein.

RETURN POLICIES AND PROCEDURES

Refunds

Within 5 days of purchase: as part of the cooling off clause (section 16 of the CPA), the pump may be returned for refund, provided that it is still within the original packaging, unused, and in the original condition.

Within 10 days of purchase: the pump may be returned for refund or replacement if it does not meet the purpose for which intended (section 20 of the CPA), provided that it is still within the original packaging, unused, and in the original condition. In such instance the pump will be returned to JoJo for an evaluation, after which an inspection report will be provided confirming whether it meets the necessary requirements for refund or replacement.

Returns/repairs

Within 12 months: should the pump not operate as specified, or cease to do so within 12 months after being purchased, the return procedure is as follows:

- **Return the pump to the store from which purchased**, together with the proof of purchase (to confirm that it is within the 12-month warranty period). Please ensure that the condition of the pump is as specified in section four of this warranty, and that it is still packed in the original packaging.
- **The store will send the pump to the nearest JoJo factory for an evaluation.**
- At JoJo's election, **(a) the pump will either be repaired** (if repairable) which repairs shall be and warranted for three months, or the balance of the 12-month period, whichever period is longer; or **(b) the pump will be exchanged** (this only applies if the pump is non-repairable, and a replacement pump in similar visual condition will be provided by JoJo).
- The evaluation (once the pump is sent back to JoJo), repair/exchange and delivery to the store will take place **within 14 days.**

Our return/repair request form is available on our website at www.jojo.co.za.

Thank you for choosing JoJo, if there is anything that you are unsure about or need assistance with, please do not hesitate to contact us.

+27 11 695 8300 | www.jojo.co.za

JoJo
FOR WATER FOR LIFE